

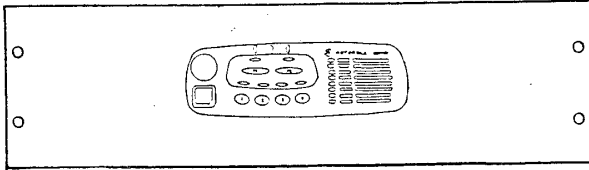

- ACM 2621 Series - **CDM 750** - Mobile Panel
- ACM 2623 Series - **CDM 1250** - Mobile Panel
- ACM 2624 Series - **CDM 1550** - Mobile Panel
- ACP 2702 Series - **Consolette Base Station Panel**
- ACM 2712 Series - **Desk Top Speaker**
- ACP 2626 Series - **GTX** - Mobile Panel
- ACP 2622 Series - **CDM 1225** - Mobile Panel
- ACM 2624 Series - **MCS 2000** - Mobile One
- ACM 2606 Series - **MCS 2000** - Model Two/Three Panels
- ACM 2500 Series - **Scanner Panels**
- ACM 2602 Series - **Spectra Panels**
- ACP 2710 Series - **Speaker Panel with Radio**
- ACP 2632 Series - **XTL 2500** - Mobile Panel
- ACP 2631 Series - **XTL 5000** - Mobile Panel

American Wireless Inc
ACM 2621 Series Panels

CDM 750 – Mobile Panel



ACP2621A CDM750 IN 5 1/4"H X 19"W PANEL.

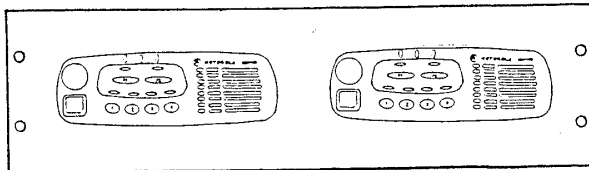

ACP2621B TWO CDM750 RADIOS IN 5 1/4"H X 19"W PANEL.

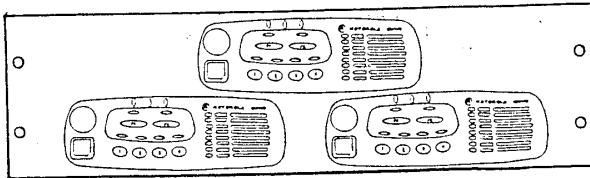

ACP2621C THREE CDM750 RADIOS IN 5 1/4"H X 19"W PANEL.

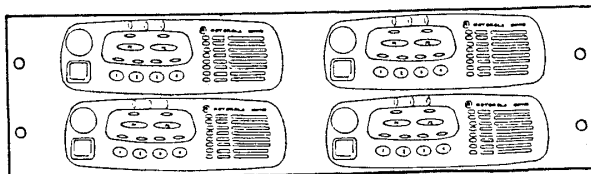

ACP2621D FOUR CDM750 RADIOS IN 5 1/4"H X 19"W PANEL.

American Wireless Inc ACM 2623 Series Panels

CDM 1250– Mobile Panel

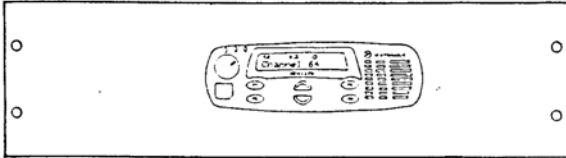

ACP 2623A CDM1250 IN 5½"H X 19"W PANEL.

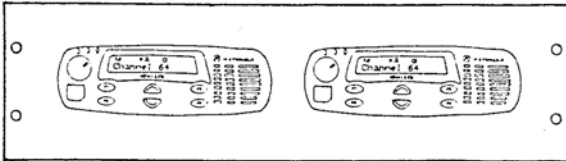

ACP 2623B TWO CDM1250 IN 5½"H X 19"W PANEL.

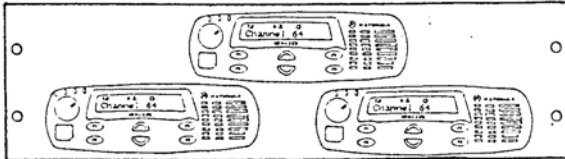

ACP 2623C THREE CDM1250 IN 5½"H X 19"W PANEL.

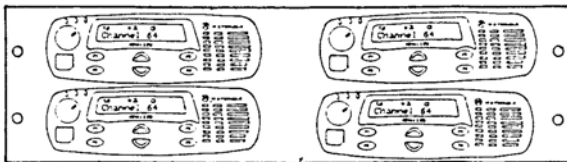

ACP 2623D FOUR CDM1250 IN 5½"H X 19"W PANEL.

American Wireless Inc
ACM 2624 Series Panels

CDM 1550- Mobile Panel

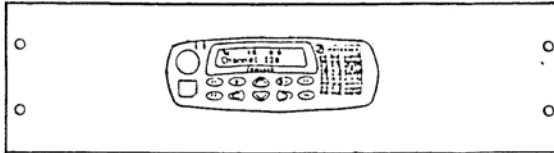

ACP 2624A ONE CDM1550 IN
5 1/4" H X 19" W PANEL.

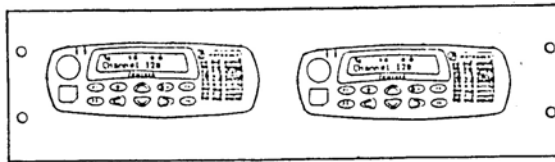

ACP 2624B TWO CDM1550 IN
5 1/4" H X 19" W PANEL.

NOTE: THIS RADIO IS TOO LARGE TO ACCOMODATE THREE OR FOUR
UNITS INTO ONE 5 1/4" PANEL

American Wireless Inc
ACP 2702 Console Base Station Panel

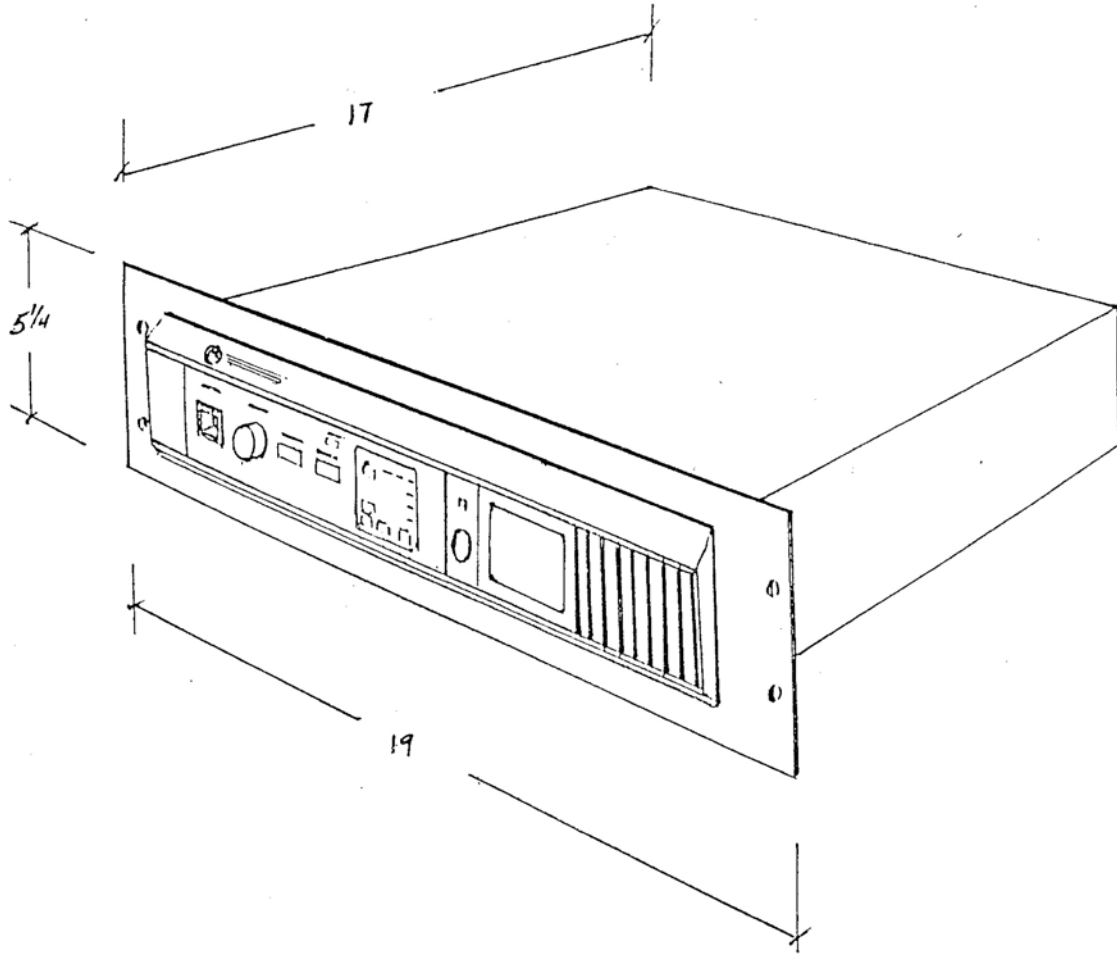

STATION EXTENDS FORWARD FROM PANEL TO ALLOW
TO BE MOUNTED INTO A DEPTH OF 15 1/2 ".

American Wireless Inc
ACM 2712 Series
Desk Top Speaker

THESE DESK TOP SPEAKERS CAN BE USED IN PLACE OF THE B1875 GOLD SPEAKER MODULE OR THE B1912A, MCC5500 SPEAKER, HAVING ALL THE FEATURES OF THE ABOVE PLUS AN LED THAT SHOWS FLASHING GREEN WHEN AUDIO IS PRESENT (ALLOWING YOU TO KNOW WHICH SPEAKER IS IN USE) AND A MUTE SWITCH, WHEN MUTED, THE LED IS AMBER AND FLASHES WHEN AUDIO IS PRESENT.

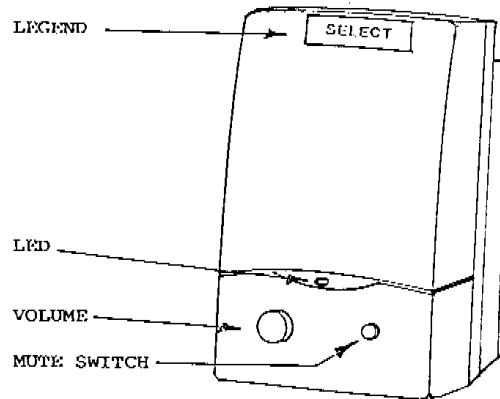

ACM2712 SPEAKER, DESK TOP . . .

THIS UNIT IS - SIX INCHES HIGH, THREE AND ONE HALF INCH WIDE AND THREE AND FIVE EIGHTS INCHES DEEP.

AVAILABLE IN BLACK (ACM2712B) OR WHITE (ACM2712W)

American Wireless Inc
ACP2626 Series Panels

GTX- Mobile Panel

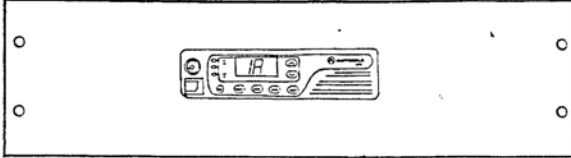

ACP 2626A ONE GTX RADIO IN
5½"H X 19"W PANEL.

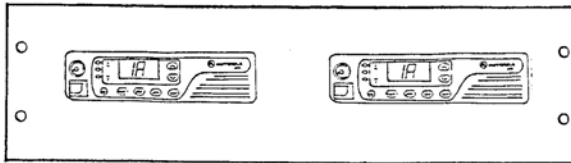

ACP 2626B TWO GTX RADIOS IN
5½"H X 19"W PANEL.

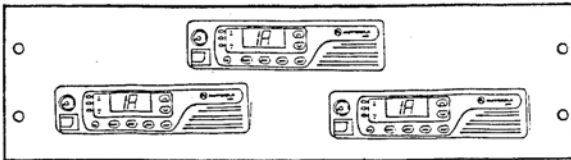

ACP 2626C THREE GTX RADIOS IN
5½"H X 19"W PANEL.

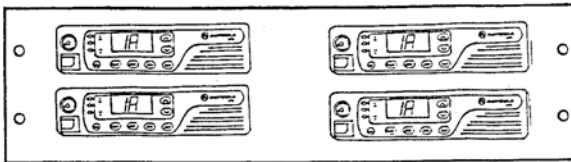

ACP 2626D FOUR GTX RADIOS IN
5½"H X 19"W PANEL.

American Wireless Inc
ACM 2622 Series Panels

CDM 1225- Mobile Panel

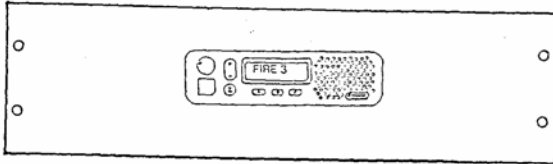

ACP 2622A CDM1225 IN 5 1/4"H X
19"W PANEL.

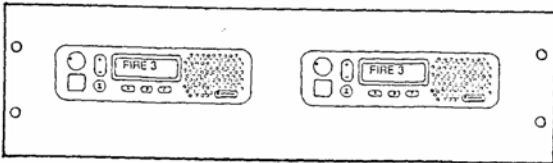

ACP 2622B TWO CDM1225 IN 5 1/4"H
X 19"W PANEL.

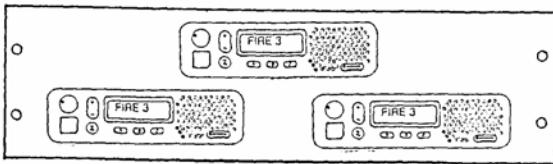

ACP 2622C THREE CDM1225 IN 5 1/4"
X 19"W PANEL.

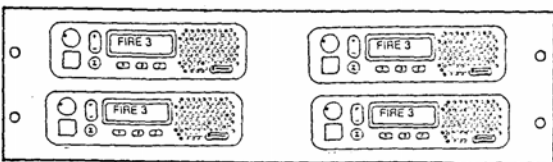

ACP 2622D FOUR CDM1225 IN 5 1/4"H
X 19"W PANEL.

American Wireless Inc
ACM 2605 Series Panels

MCS2000 – Model One

THESE RADIOS CAN BE INSTALLED IN OTHER PANEL BESIDE THOSE SHOWN AND CAN BE MOUNTED WITH EQUIPMENT OTHER THAN THE MODEL ONE. THIS UNDER SPECIAL QUOTE.

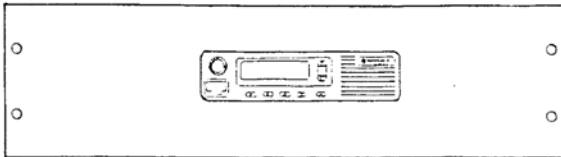

ACP2605A MCS2000 MODEL ONE
IN 5 1/4"H X 19"W
PANEL

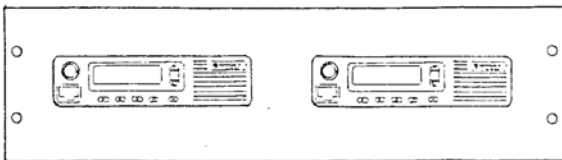

ACP2605B TWO MCS2000 MODEL
ONE IN A 5 1/4"H
X 19"W PANEL

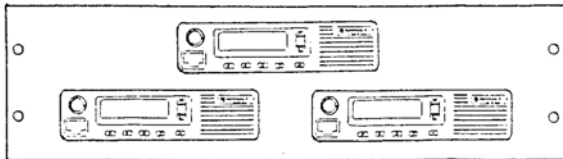

ACP2605C THREE MCS2000 MODEL
ONE IN A 5 1/4"H
X 19"W PANEL

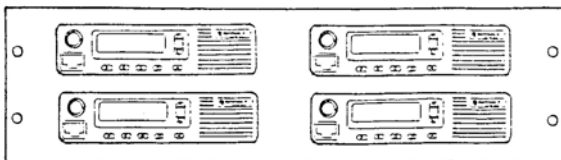

ACP2605D FOUR MCS2000 MODEL
ONE IN A 5 1/4"H
X 19"W PANEL

American Wireless Inc
ACP 2606 Series
MCS2000 Model Two / Three Panels

RADIOS CAN BE INSTALLED IN VARIOUS PANEL CONFIGURATIONS
AND MAY BE COMBINED WITH OTHER EQUIPMENT IE: SCANNERS ETC.
PLEASE CALL FOR QUOTATION

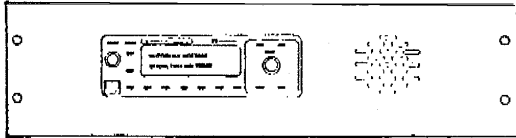

ACP 2606A

MCS2000 IN 5 1/4"H
X 19"W PANEL WITH SPEAK
(SPEAKER PROVIDED)

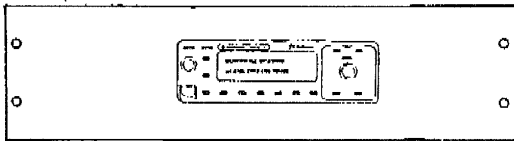

ACP 2606B

MCS2000 IN 5 1/4"H
X 19"W PANEL. (NO
SPEAKER)

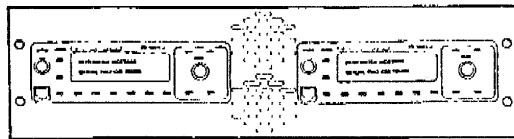

ACP 2606C

TWO MCS2000 IN 5 1/4"H
X 19"W PANEL WITH SPEAK
(SPEAKERS PROVIDED)

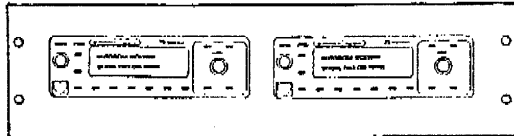

ACP 2606D

TWO MCS2000 IN 5 1/4"H
X 19"W PANEL. (NO
SPEAKERS)

NOTE: THE MODELS LISTED ARE STANDARD VERSIONS.
PLEASE CALL FOR VARIATIONS IE: DASH MOUNT / TRUNK MOUNT ETC.

American Wireless Inc ACM 2500 Series Scanner Panels

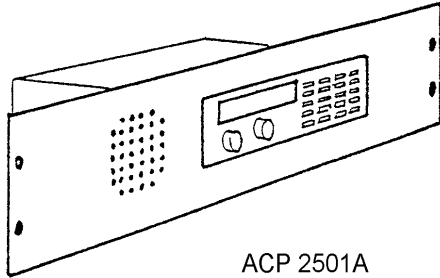

ACP 2501A

*SCANNER AND SPEAKER PANEL
MOUNTED. (SPEAKER PROVIDED
BY DONCO)*

ACP 2501B

*SCANNER PANEL MOUNTED.
NO SPEAKER*

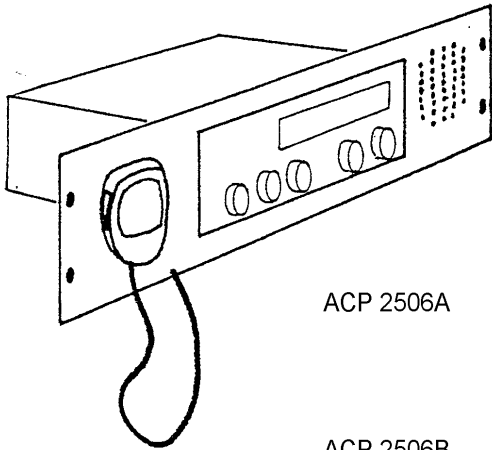

ACP 2506A

*RADIO WITH MIC AND SPEAKER
PANEL MOUNTED. (SPEAKER
PROVIDED)*

ACP 2506B

*RADIO WITH SPEAKER PANEL
MOUNTED. NO MIC. (SPEAKER
PROVIDED)*

ACP 2506C

*RADIO PANEL MOUNTED.
NO MIC AND NO SPEAKER*

ALL SCANNERS AND CB RADIOS SHOULD BE SENT TO US FOR PANEL MOUNTING. TURN AROUND TIME ABOUT THREE WEEKS.

American Wireless Inc ACM 2602 Series Panels

W4, W5 & W7 SERIES RADIOS & W9 CONTROL HEADS
OTHER CONFIGURATIONS AVAILABLE BY QUOTE



ACP2602A SPECTRA IN 5 1/4"H X 19"W PANEL WITH SPEAKER (SPEAKER PROVIDED)

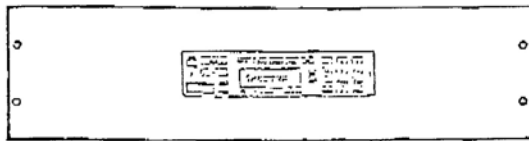

ACP2602B SPECTRA IN 5 1/4"H X 19"W PANEL (NO SPEAKER)

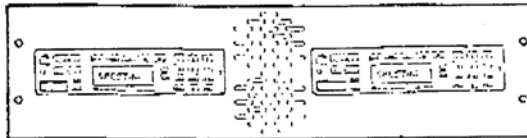

ACP2602C TWO SPECTRAS IN 5 1/4"H X 19"W PANEL WITH TWO SPEAKERS (SPEAKERS PROVIDED)

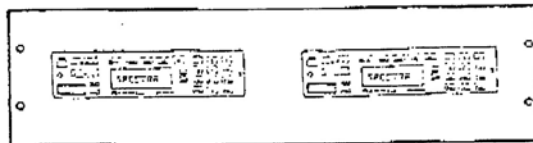

ACP2602D TWO SPECTRAS IN 5 1/4"H X 19"W PANEL (NO SPEAKERS)

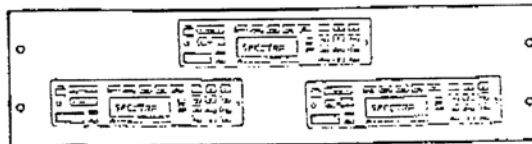

ACP2602E THREE SPECTRAS IN 5 1/4"H X 19"W PANEL (NO SPEAKERS)

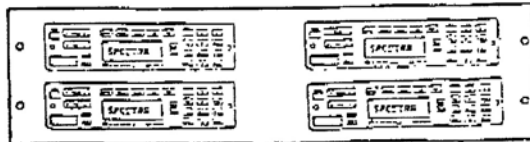

ACP2602F FOUR SPECTRAS IN 5 1/4"H X 19"W PANEL (NO SPEAKERS)

American Wireless Inc ACP2710 SP

ACP2710 - SPECIAL QUOTE

TWO SPEAKER PANEL, WITH OR WITHOUT MICROPHONE AND PUSH TO TALK SWITCH CAN BE PROVIDED WITH PROVISION FOR OTHER EQUIPMENT, IN THE CENTER, BETWEEN THE SPEAKERS, SPACE PERMITTING. THIS COULD BE A SCANNER, MOBILE OR OTHER EQUIPMENT.

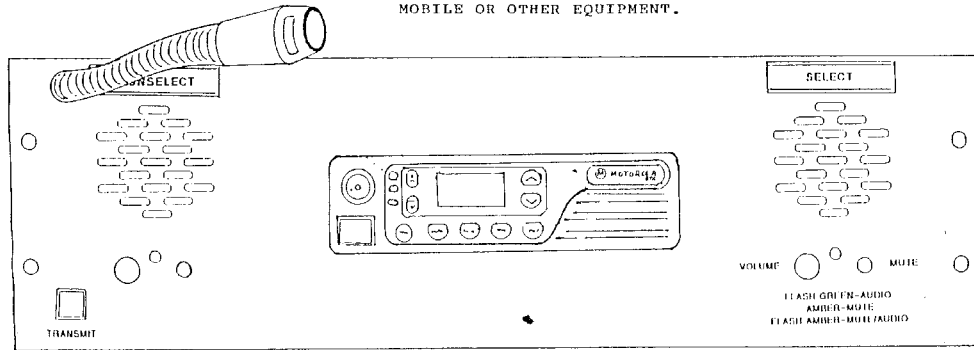

UNDER SPECIAL QUOTE, THIS PANEL IS AVAILABLE WITH TWO SPEAKERS, WITH OR WITHOUT THE MICROPHONE AND PUSH TO TALK SWITCH.

THE SPEAKERS CAN BE USED IN PLACE OF THE DESK TOP, B1875A, GOLD SPEAKER MODULE (CUBE SPEAKER) OR THE B1912 SPEAKER ASSOCIATED WITH THE MCC5500 CONTROLLER.

THE MICROPHONE AND PUSH TO TALK SWITCH, THE SPEAKERS AND THE NECESSARY CABLE AND CONNECTORS ARE PROVIDED WITH THIS PANEL. OPERATOR CONTROLS ARE PUSH TO TALK SWITCH, VOLUME, MUTE SWITCH AND VISUAL STATUS LED.

PANEL IS AN (RU3) - 5 1/4" H X 19" W

American Wireless Inc
ACP 2632 Series Panels

XLT2500- Mobile Panel

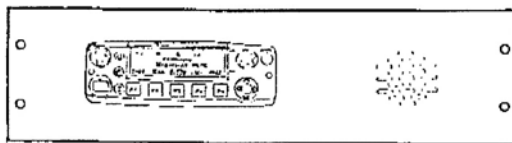

ACP 2632A ONE XLT2500 IN 5½"H X
19"W PANEL WITH SPEAKER.
(SPEAKER PROVIDED)

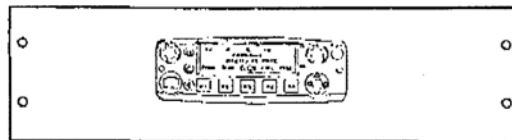

ACP 2632B ONE XLT2500 IN 5½"H X
19"W PANEL. (NO SPEAKER)

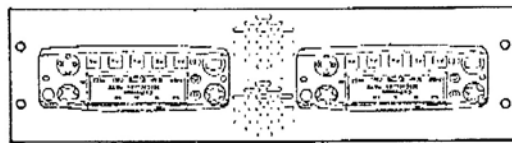

ACP 2632C TWO XLT2500 IN 5½"H X
19"W PANEL WITH SPEAKERS.
(SPEAKER PROVIDED)

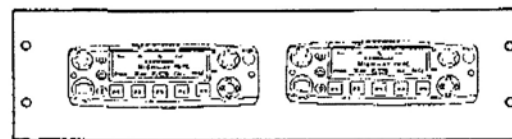

ACP 2632D TWO XLT2500 IN 5½"H X
19"W PANEL (NO SPEAKERS)

American Wireless Inc ACP 2631 Series Panels

XLT5000- Mobile Panel

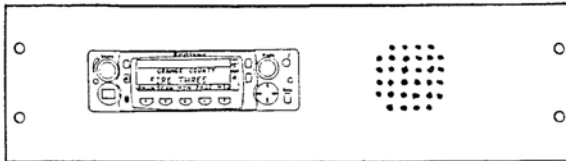

ACP 2631A XTL5000 IN 5¼"H X 19"W
PANEL WITH SPEAKER.
(SPEAKER PROVIDED)

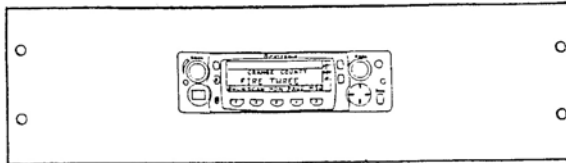

ACP 2631B XTL5000 IN 5¼"H X 19"W
PANEL. (NO SPEAKER)

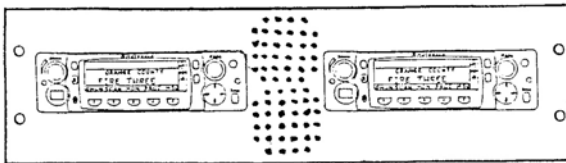

ACP 2631C TWO XTL5000 IN 5¼"H X
19"W PANEL WITH SPEAKERS.
(SPEAKERS PROVIDED)

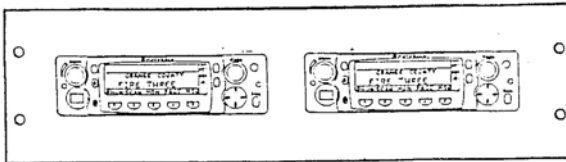

ACP 2631D TWO XTL5000 IN 5¼"H X
19"W PANEL. (NO SPEAKERS)

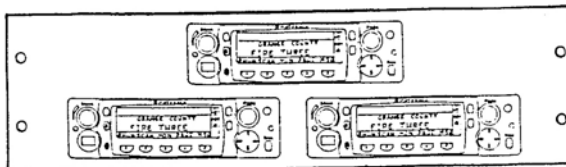

ACP 2631E

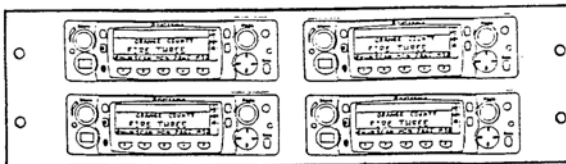

ACP 2631F FOUR XTL5000 IN 5¼"H X
19"W PANEL. (NO SPEAKERS)